

Specifications

Model	HX-40	HX-40AM	HX-40DAM	HX-40RAM
Detection method	Passive infrared		Passive infrared & Microwave	Passive infrared
Anti-masking	-	✓	✓	✓
PIR Coverage	12 m (40') 85° wide / 94 zones			
PIR distance limit	4.0 m, 5.5 m, 9.0 m (13'1", 18'1", 29'6")			
Detectable speed	0.3 m/s - 1.5 m/s (1'1/s - 4'11"/s)			
Sensitivity	2.0°C (3.6°F) at 0.6 m/s			
Power input	9.5 - 18 V DC		3 - 7.2VDC Lithium Battery (CR123 x 3, CR2 x 3, 1/2AA x 3, 1/2AA x 6)	
Operating Voltage			2.5 - 9VDC	
Current draw	35 mA (max.) at 12 V DC	40 mA (max.) at 12 V DC	50 mA (max.) at 12 V DC	30µA(standby) / 4 mA (max) at 3VDC
Alarm period	2.0 ± 1 sec			
Warm-up period	Approx. 60 sec. (LED blinks)		Approx. 90 sec. (LED blinks)	
Alarm output	Form C 28 V DC 0.2 A (max.)		Form C -Solid State Switch- 10VDC 0.01A max	
Tamper output	N.C. 28 V DC, 0.1 A (max.) N.C. open when cover removed		Form C. 28V DC, 0.1A max. activates when cover is removed	
Trouble output	-	N.C. 28 V DC, 0.1 A (max.)		N.C./N.O. Selectable -Solid State Switch- 10VDC 0.01A max
Aux input	N.C. 28 V DC, 0.1 A (max.)			
LED indicator	Red: Warm-up, Alarm	Red: Warm-up, Alarm, Trouble	Red: Warm-up, Alarm, Trouble Green: Warm-up, PIR detect, Trouble Yellow: Warm-up, MW detect	Disable: During normal operation. Enable: During WALK TEST or LED SW on. Red: Warm-up, Alarm, Trouble, Low battery
RF interference	No alarm 10 V/m			
Operating temperature	-20 - +60°C (-4 - +140°F)			
Environment humidity	95% max.			
Weatherproof	IP55			
Mounting	Wall			
Mounting height	2.5 - 3.0 m (8'2" - 9'10")			
Bracket adjust angle	Vertical: ±20° Horizontal: ±95°			
Weight	600 g (21.2 oz.)		700 g (24.7 oz.)	
Accessories	Bracket, Hood, Area masking seal, Screw kit (3 x 10-2, 4 x 20 - 4)		Bracket, Hood, Area masking seal, Screw kit (3 x 10-2, 4 x 20-4) Velcro tape x 2, Alarm cable, Battery lead x 2, Dummy battery kit	

*Specifications and designs are subject to change without prior notice.
*Batteries and wireless transmitters are not included these products.

Coverage

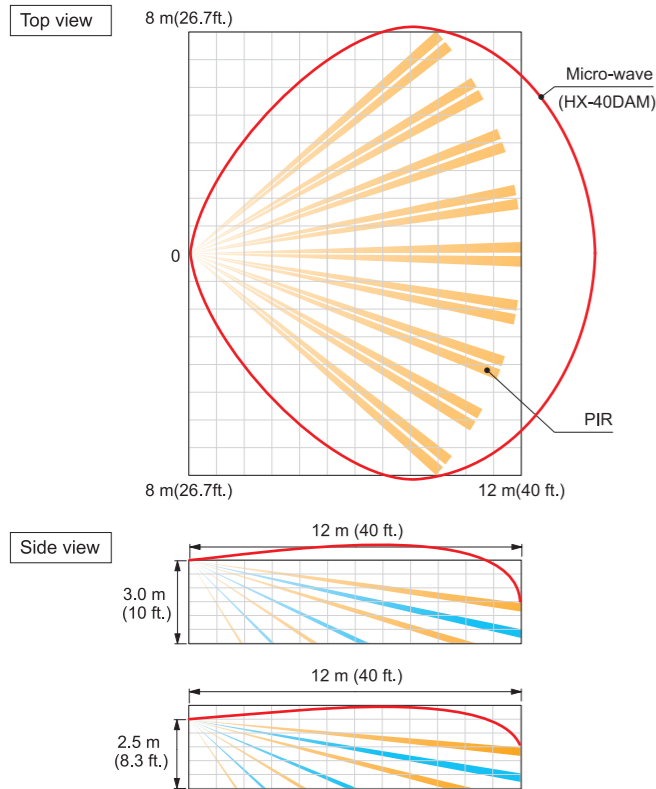

Dimensions

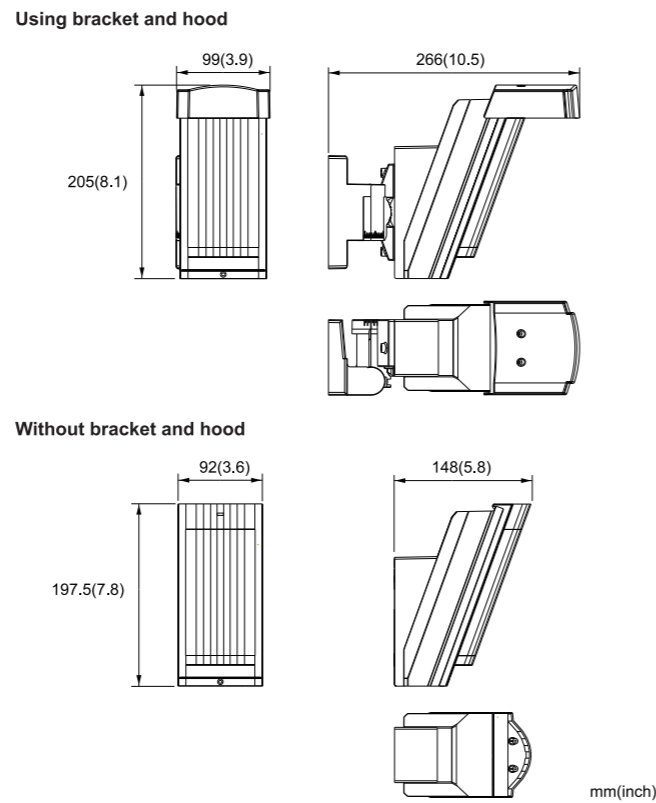

OPTEX CO., LTD. (JAPAN)
URL: <http://www.optex.net/>

OPTEX INC. (U.S.)
URL: <http://www.optexamerica.com/>

OPTEX DO BRASIL LTDA. (Brazil)
URL: <http://www.optex.net/br/es/sec/>

OPTEX (EUROPE) LTD. / EMEA HQ (U.K.)
URL: <http://www.optexeurope.com/>

OPTEX TECHNOLOGIES B.V. (The Netherlands)
URL: <http://www.optex.nl/>

OPTEX SECURITY SAS (France)
URL: <http://www.optex-security.com/>

OPTEX SECURITY Sp.z o.o. (Poland)
URL: <http://www.optex.com.pl/>

OPTEX PINNACLE INDIA, PVT., LTD. (India)
URL: <http://www.optex.net.in/en/sec/>

OPTEX KOREA CO.,LTD. (Korea)
URL: <http://www.optexkorea.com/>

OPTEX (DONGGUAN) CO.,LTD. SHANGHAI OFFICE (China)
URL: <http://www.optexchina.com/>



High Mount Outdoor Detector

HX-40 series

- HX-40 : 2 PIRs standard model**
- HX-40AM : Anti-masking model**
- HX-40DAM : 2 PIRs with micro-wave model**
- HX-40RAM : Battery operated model**



HX-40 series

(12m/40ft.)
high mount multi-purpose detector for exterior use.

HX-40 2 PIRs standard model

Product features

Catch performance

The HX Series features superb Catch Performance. The most important element in reliable outdoor detector is accuracy to distinguish a human from a pet. The exclusive pyro element on board enables the HX to project an ideal detection pattern, thus allowing for more accurate detection of humans and less false alarms.

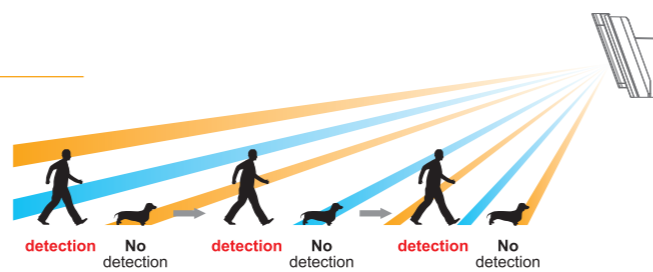

Adjustability

Outdoor environments are full of false alarm factors like vegetation and reflective surfaces. Pre-survey before installing enables you to find the ways to minimize possible false alarms. The HX detection pattern can easily be adjusted to avoid these possible false alarms by using the included masking strips.



Masking seal(Horizontal)

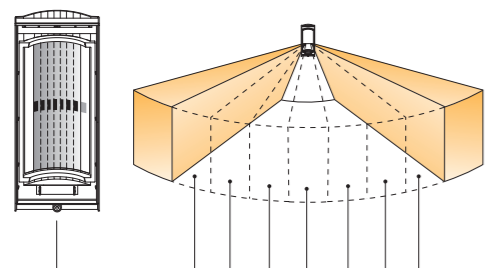

Masking seal(Detection length)

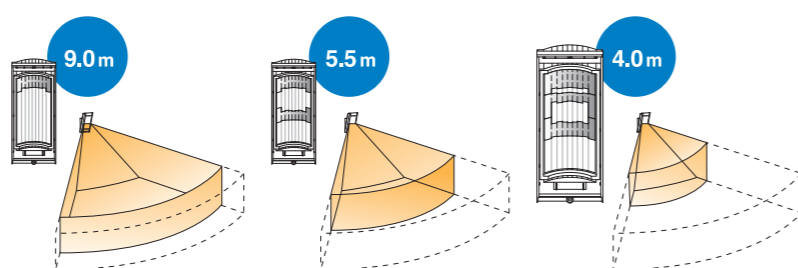

Slope friendliness

Not all outdoor ground is flat like most indoor environments. Steep slopes can cause negative effects on the catch performance feature. The adjustable included bracket enables the HX to maintain the optimal catch performance.

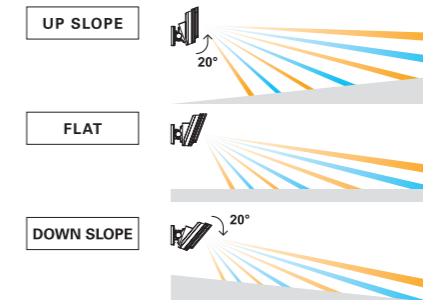

180° horizontal angle adjustable bracket

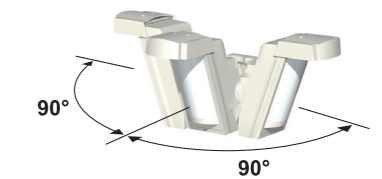

Basic performance

- Mounting height 2.5-3.0m
- Intelligent AND detection logic with unique pyro-element
- Double conductive shielding
- Advanced temperature compensation logic
- Summer night compensation logic
- Vegetation sway analysis logic

Product line up

HX-40AM Anti-masking model



Active IR digital anti-masking

When an object is placed close to the lens surface, for a period of more than 180 seconds, the IR Anti-Masking circuit will activate and generate a trouble signal.

HX-40RAM Battery operated model



Save installation time and cost.

HX-40RAM is battery operated model therefore requires no complicated wiring.



Battery box for numerous battery types

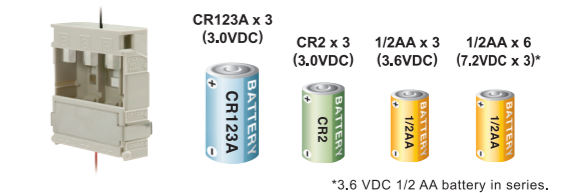

*3.6 VDC 1/2 AA battery in series.

HX-40DAM 2 PIRs with micro-wave model



Micro-wave Intelligent Quantification logic



The HX-40DAM continuously monitors wave changes and automatically cancels the signal caused by swaying grass.

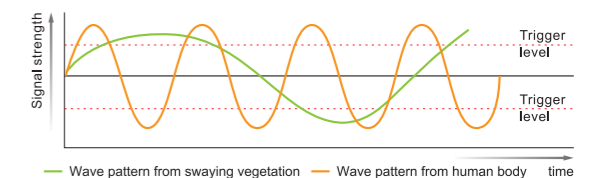

Application



Residential site



Construction site



Industrial site

*According to our survey on April, 2010.