

Coverage

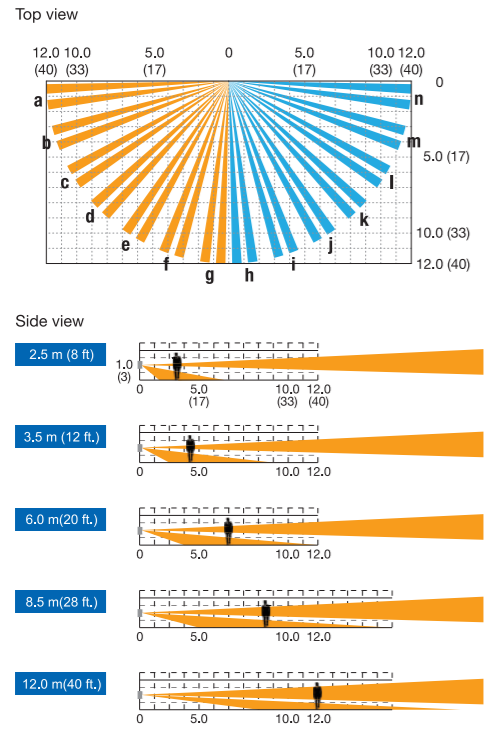

Dimensions

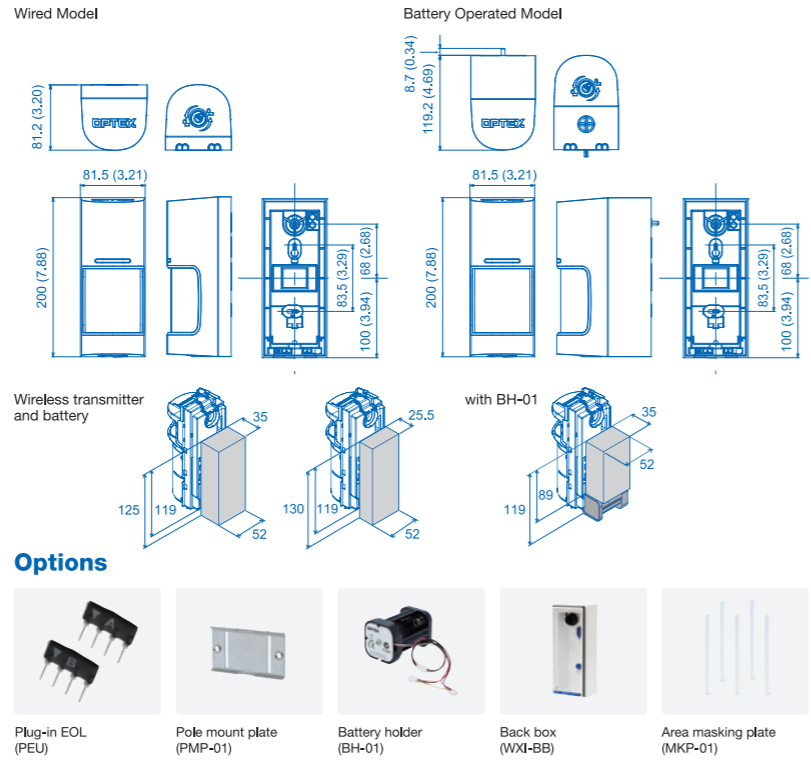

Specifications

Model	WXI-ST	WXI-AM	WXI-R	WXI-RAM
Detection method	Passive infrared		Passive infrared	
PIR coverage	180° wide		180° wide	
PIR zones	Horizontal 14 pairs, vertical 2 layers		Horizontal 14 pairs, vertical 2 layers	
PIR distance limit	2.5 to 12 m (Stepless adjustment)		2.5 to 12 m (Stepless adjustment)	
Detectable speed	0.3 to 2.0 m/s (1' to 6'7"/s)		0.3 to 2.0 m/s (1' to 6'7"/s)	
Sensitivity	2.0 °C (3.6°F) at 0.6 m/s Selectable for each side individually		2.0 °C (3.6°F) at 0.6 m/s Selectable for each side individually	
Power input	9.5 to 18 VDC		3 to 3.6 V DC lithium batteries	
Current draw	21 mA max. at 12 VDC	23 mA max. at 12 VDC	15 µA stand-by 4 max. at 3 V DC except walk test	16 µA stand-by 4 max. at 3 V DC except walk test
Alarm period	2.0 ±1 sec.		2.0 ±1 sec.	
Warm-up period	60 sec. or less (LED blinks)		60 sec. or less (LED blinks)	
Alarm (R) output	28 VDC 0.1 A max. [Individual; Right or General], [N.O. or N.C.] are selectable		Solidstate switch, 10 V DC 0.01 A max. [Individual; Right or General], [N.O. or N.C.] are selectable	
Alarm (L) output	28 VDC 0.1 A max. [Individual; Left or General], [N.O. or N.C.] are selectable		Solidstate switch, 10 V DC 0.01 A max. [Individual; Left or General], [N.O. or N.C.] are selectable	
Trouble output	-	N.C. 28 VDC 0.1 A max.	Solidstate switch, 10 V DC 0.01 A max. [N.O. or N.C.] is selectable	
Tamper output	N.C. 28 VDC 0.1 A max. Open when either the cover, main or base unit is removed		Tamper output is shared with trouble output.	
LED indicator (DIP switch ON or Walk test)	Red LED ; 1. Warm-up 2. Alarm	Red LED ; 1. Warm-up 2. Alarm 3. Masking detection	Red LED ; 1. Warm-up 2. Alarm	Red LED ; 1. Warm-up 2. Alarm 3. Masking detection
Operation temperature	-30 °C to +60 °C (-22°F to +140°F)		-30 °C to +60 °C (-22°F to +140°F) except batteries	
Environment humidity	95% max.		95% max.	
International protection	IP 55		IP 55	
Mounting	Wall, Pole (Outdoor, Indoor)		Wall, Pole (Outdoor, Indoor)	
Mounting height	0.8 to 1.2 m (2'7" to 4')		0.8 to 1.2 m (2'7" to 4')	
Weight	420 g (14.8 oz.)	440 g (15.5 oz.)	600 g (21.2 oz.)	
Accessories	Mounting screw (4 x 20 mm) x 2, lock screw x 1		Connector for POWER and ALARM (R), Connector for ALARM (L) Connector for TROUBLE, Velcro tape Mounting screw (4 x 20 mm) x 2, Lock screw x 1	

* Specifications and designs are subject to change without prior notice.
* These units are designed to detect an intruder and activate an alarm control panel. Being only a part of a complete system, we cannot accept responsibility for any damages or other consequences resulting from an intrusion.

Unit: years (approx.)

Interval (sec.)	WXI-R		WXI-RAM	
120	5	120	5	
CR123A (3V DC, 1300 mAh)	5	3.5	5	3.5
CR2 (3V DC, 750 mAh)	3	2	3	2
1/2AA (3.6V DC, 1000 mAh)	4	2.5	4	2.5



180 degree PANORAMIC OUTDOOR DETECTOR

WX Infinity series

WIRED MODEL

WXI-ST : 12m(40ft), 180 degrees, standard
WXI-AM : with Anti-masking

BATTERY OPERATED MODEL

WXI-R : Battery operated 12m(40ft), 180 degrees
WXI-RAM : with Anti-masking



External sensing you can depend upon

The OPTEX WXI series is a family of external sensors built upon our years of proven experience. The series utilizes both analog and digital technologies to detect approaching intruders before they gain access into your protected area.

With its comprehensive 180°field of view and capabilities to tailor its setting to meet the environment around your premise, the WXI series will provide an effective solution for new and existing security systems.



OPTEX CO.,LTD. (JAPAN)
www.optex.net

OPTEX INC. / AMERICAS HQ (U.S.)
www.optexamerica.com

OPTEX (EUROPE) LTD. / EMEA HQ (U.K.)
www.optex-europe.com

OPTEX TECHNOLOGIES B.V. (The Netherlands)
www.optex.eu

OPTEX SECURITY SAS (France)
www.optex-europe.com/fr

OPTEX SECURITY Sp.z o.o. (Poland)
www.optex.com.pl

OPTEX PINNACLE INDIA, PVT., LTD. (India)
www.optexpinnacle.com

OPTEX KOREA CO.,LTD. (Korea)
www.optexkorea.com

OPTEX (DONGGUAN) CO.,LTD. SHANGHAI OFFICE (China)
www.optexchina.com

OPTEX (Thailand) CO., LTD. (Thailand)
www.optex.co.th

180 degree wall-to-wall coverage

Right coverage with flexibility to eliminate blind spots



Individual left/right settings

Individual alarm outputs

An installation of a WXI values 2 detectors because it triggers alarm signals both left and right side individually. So it's useful for PTZ activation, direction recognition and changing detection pattern by day and night with a CP.

Individual sensitivity setting

Detection sensitivity can be set to High, Medium and Low by left and right switches individually.

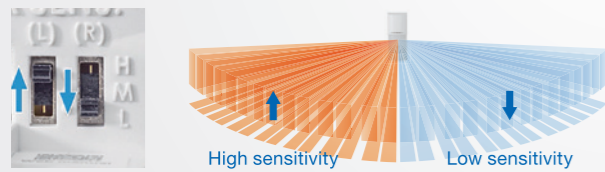

Individual detection area size

Detection distance can be easily adjusted between 2.5m(8ft) and 12m(40ft) by left and right sliding lower PIR units individually.

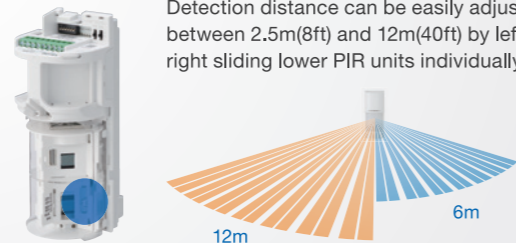

Reliability

Self-learning IR digital anti-masking function

WXI detects covering objects on lens surface. IR digital anti-masking function optimizes trigger level of trouble outputs generated by masking depends on status of lens surface. A well-calibrated adjustment for both of emitting and receiving level of IR LED fluctuating by temperature contributes to stable anti-masking.

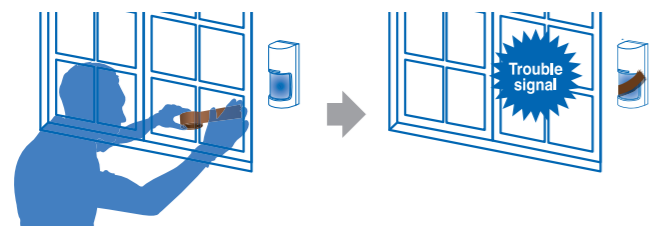

Sunlight canceling

The trigger level of anti-masking is automatically adjusted when sunlight is too strong.

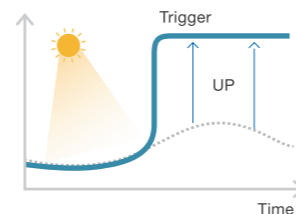

Rainwater and insect canceling

Small objects such as a spider or rainwater can be cancelled.



AND logic function to reduce false alarms

WXI only triggers an alarm signal when both upper and lower detection areas detect movement.

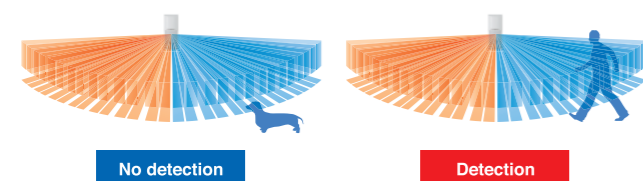

SMDA logic (Super Multidimensional Analysis)

It can differentiate among various noise factors such as climate changes and vegetation sways and genuine intrusions.



Easy and flexible detection area settings

Area masking shutter

By rotary sliding area masking shutter, the size of detection areas can be changed.

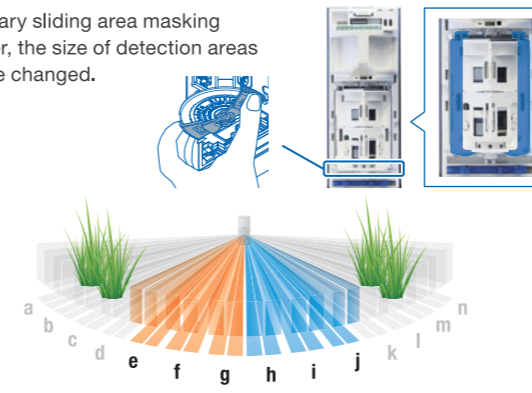

When area masking shutter's position is that Left is d and right is k, detection area a-d and k-n are masked.

Area masking plate

Unwanted detection areas can be masked by optional area masking plate (MKP-01).

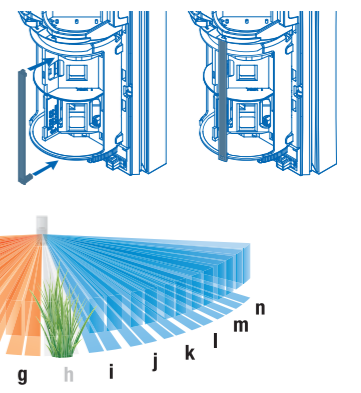

When a MKP-01 is set on position h, detection area h is masked.

Mechanical features

EOL module socket (WXI-ST, AM only)

Optional EOL (end of line) resistor modules are available.

Wide LED window

Wide and bright LED for a recognition from a distance.

Screw free design

You can open / close front cover and remove / put main unit without any screws. It contributes to reduction of installation time



Back tamper

A tamper output is generated when unit is removed from the wall.

Pole mount plate (option PMP-01)

Suitable for a metal band up to 23 mm (1 inch) in width.



Applications



For residential



For rooftop



For substation

Basic common features

- Double conductive shielding
- Cover tamper

Web based manual for wired models

<http://navi.optex.net/manual/50196>



Web based manual for battery operated models

<http://navi.optex.net/manual/50198>

